

## THON7 HONDA CR-V 2018>

Item	Qty	Description	Item	Qty	Description
A	1	THON7 Crossmember	D	2	M16 x 50 Bolts & Nyloc Nuts
B1	1	L/H Side Arm	E	8	M10 x 35 Bolts, 4 Nyloc Nuts & 4 S/P Washers
B2	1	R/H Side Arm	F	6	M8 x 30 Bolts (10.9) & S/P Washers
C	1	Extension	G	1	M16 x 110 Bolt & Nyloc Nut
			H	2	M12 x 45 Bolts & Nyloc Nuts
			J	1	M12 x 130 Bolt & Nyloc Nut
			K	4	10 x 30 Flat Washers
			L	8	10 x 25 Flat Washers
			M	4	12 x 25 Flat Washers
			N	6	8 x 25 H/D Flat Washers
			P	2	16 x 27 Flat Washers
			R	4	THON7 1mm Shims
			S	2	M16 Black Bolt Caps
			T1	1	30mm O/D x 60mm Long Spacer Tube
			T2	2	40mm O/D x 20mm Long Spacer Tubes

### BUMPER REMOVAL:

1. Remove the under tray, four fixings. Remove two additional fixings from the outside lower edge of the rear bumper.
2. Remove two fixings from each wheel arch then unclip wheel arch trim, this will reveal an additional two fixings each side to remove.
3. Remove four fixings from around the boot opening. Pull bumper tips sideways to release from the vehicle body work then rearwards to remove.
4. Remove the rear impact beam (this is not refitted with the Towbar assembly).
5. Drill out each dimple using a cone cutter until they join up and allow you to remove the material from each chassis opening (See: FIG 1) File smooth all sharp edges and paint to prevent corrosion.
6. Lower and support the exhaust.

### TOWBAR INSTALLATION:

1. Fix Item A to the rear panel using Item F and Item N.
2. Fix Item A to the central towing eye using Item G with Item P and Item T2 and R as spacers. (Use Item R as necessary to shim the gap)
3. Insert items B1 and B2 into each correct chassis and fix to the chassis lower face using items E and Items K.
4. Fix items B1 and B2 to Item A using Item E and item L.
5. Fix Item C to Item A using Items H with item M and Item J with Items M ensuring Item T1 is fitted between the lower mounting point.
6. Using Item D fix your desired ball bracket and wiring plate (not supplied in this kit) to Item C.
7. Fully tighten all fixings ensuring the Towbar is rigid, square, and secure. Fit Item S to central towing eye fixing (Item G).
8. Rehang the exhaust.
9. Cut the rear bumper, under tray and if fitted hands free unit as per the below sketch and fit to the vehicle.

FIG 1: Rear Panel Opening (L/H Shown)

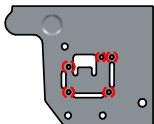

Bumper & Under Tray Cut (outside View)

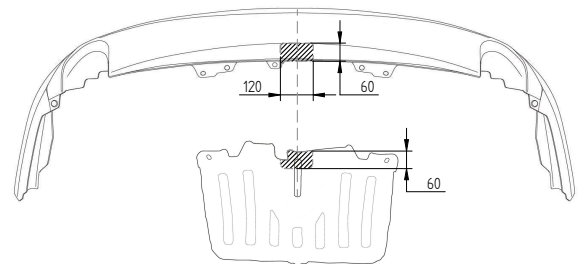

Hands Free Unit Cut  
Take Care Not To Cut Sensor

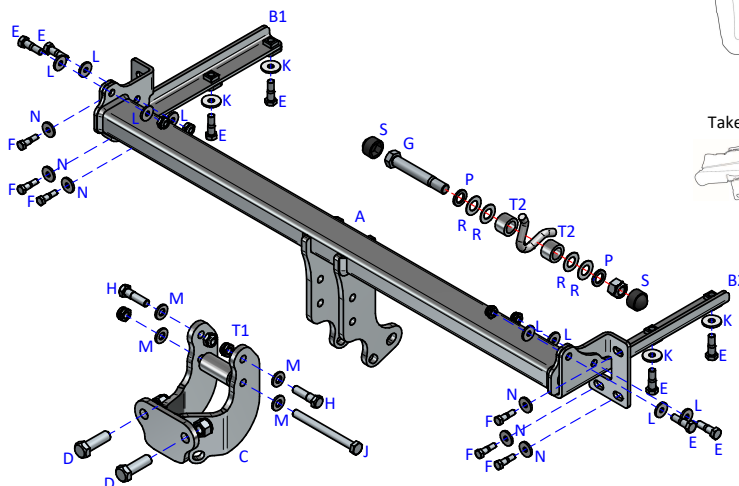
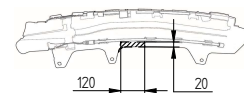

### Notes:

1. For Torque settings see general notes overleaf.
2. Nose load limits and vehicle manufacturer's trailer / caravan weight limits must be observed.